

Data Sheet



Article number: 5725027217

Description: NSK Cirkular flange unit UCFC217D1

Measures

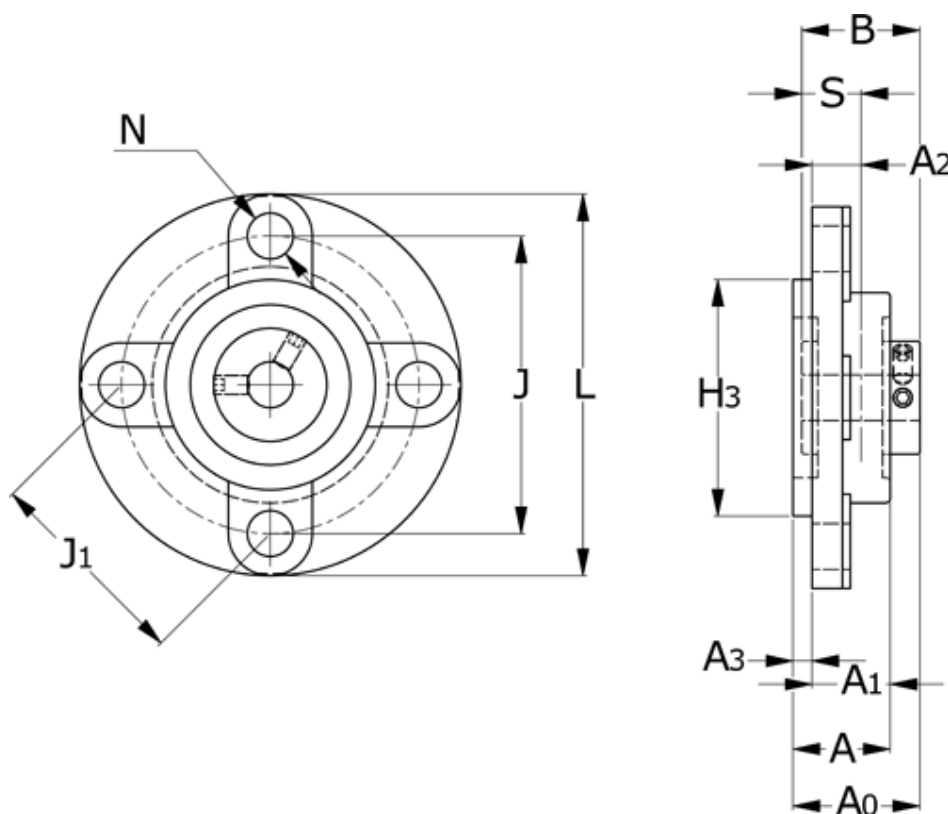

A = 63	J1 = 147.1
A0 = 87.6	L = 250
A1 = 45	N = 23
A2 = 18	S = 34.1
A3 = 18	Shaft = 85
B = 85.7	
H3 = 180	
J = 208	